

FIELD TILES

FLAT

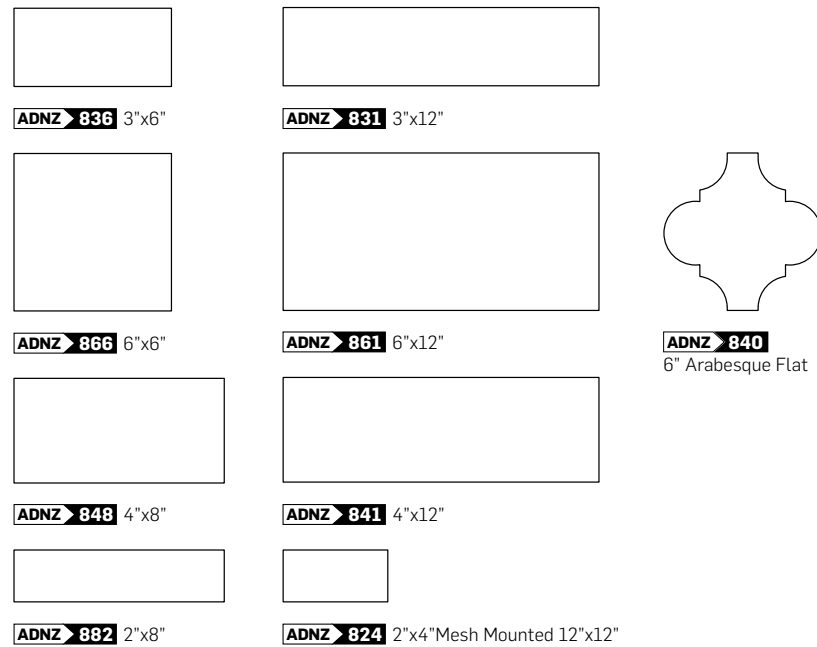

TRIMS

FINISHING EDGES

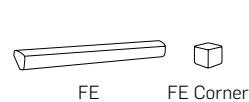

- ADNZ 506** FE 0.4"x6"
- ADNZ 508** FE 0.4"x8"
- ADNZ 500** FE Corner

FLAT BULLNOSES

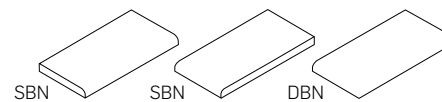

- ADNZ 805** 3"x6" SBN 6"
- ADNZ 806** 3"x6" SBN 3"
- ADNZ 807** 3"x6" DBN Right
- ADNZ 808** 3"x6" DBN Left
- ADNZ 803** 6"x6" SBN
- ADNZ 804** 6"x6" DBN
- ADNZ 810** 4"x8" SBN 4"
- ADNZ 811** 4"x8" SBN 8"
- ADNZ 812** 4"x4" DBN
- ADNZ 800** 2"x2" DBN
- ADNZ 826** 2"x6" SBN 6"
- ADNZ 828** 2"x8" SBN 8"

FLAT GLAZED EDGES

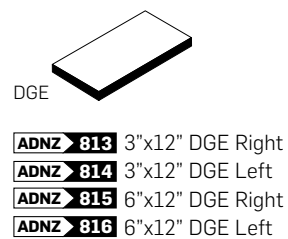

BEVELED

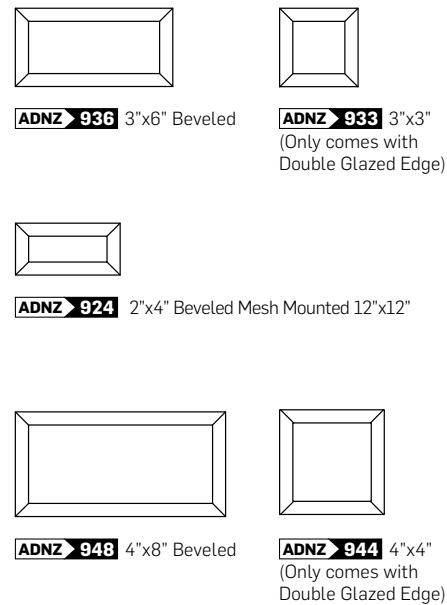

TRIMS

BEVELED GLAZED EDGES

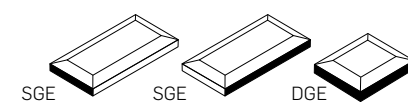

- ADNZ 907** 3"x6" Beveled SGE 3"
- ADNZ 908** 3"x6" Beveled SGE 6"
- ADNZ 933** 3"x3" Beveled DGE
- ADNZ 911** 4"x8" Beveled SGE 4"
- ADNZ 910** 4"x8" Beveled SGE 8"
- ADNZ 944** 4"x4" Beveled DGE

DECORATIVE ACCESSORIES

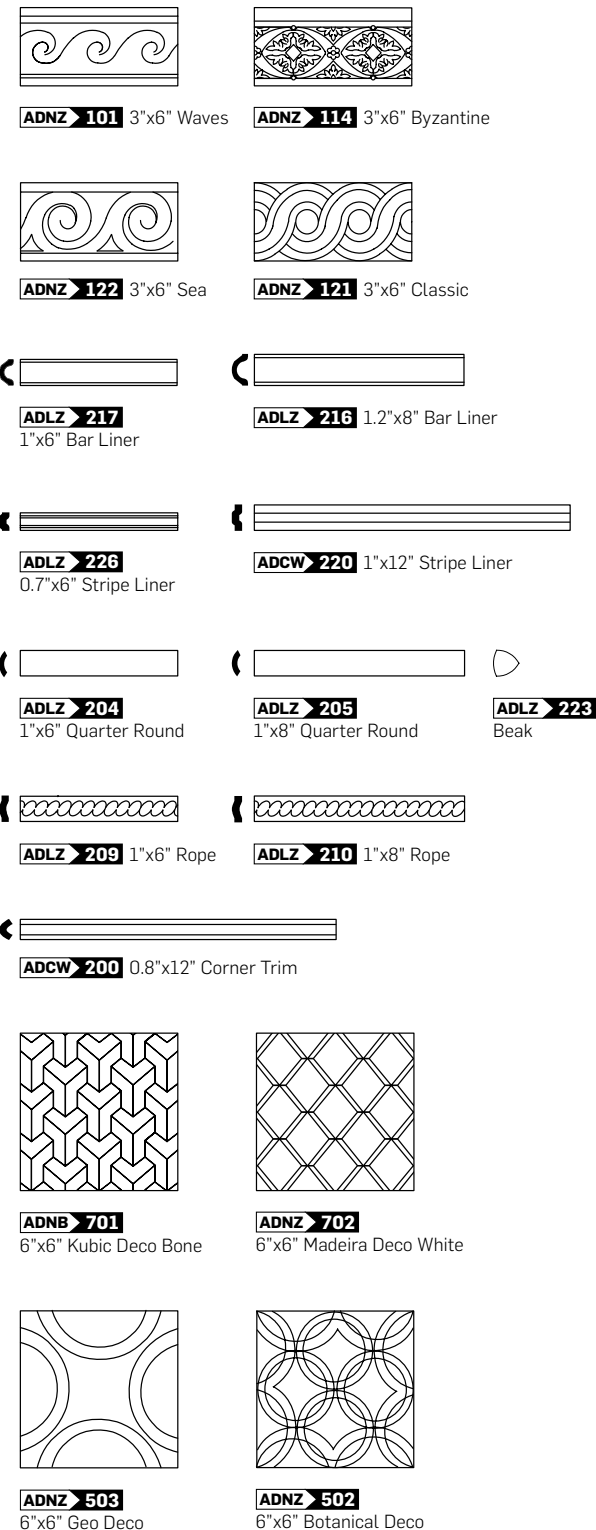

FINISHING TOUCHES

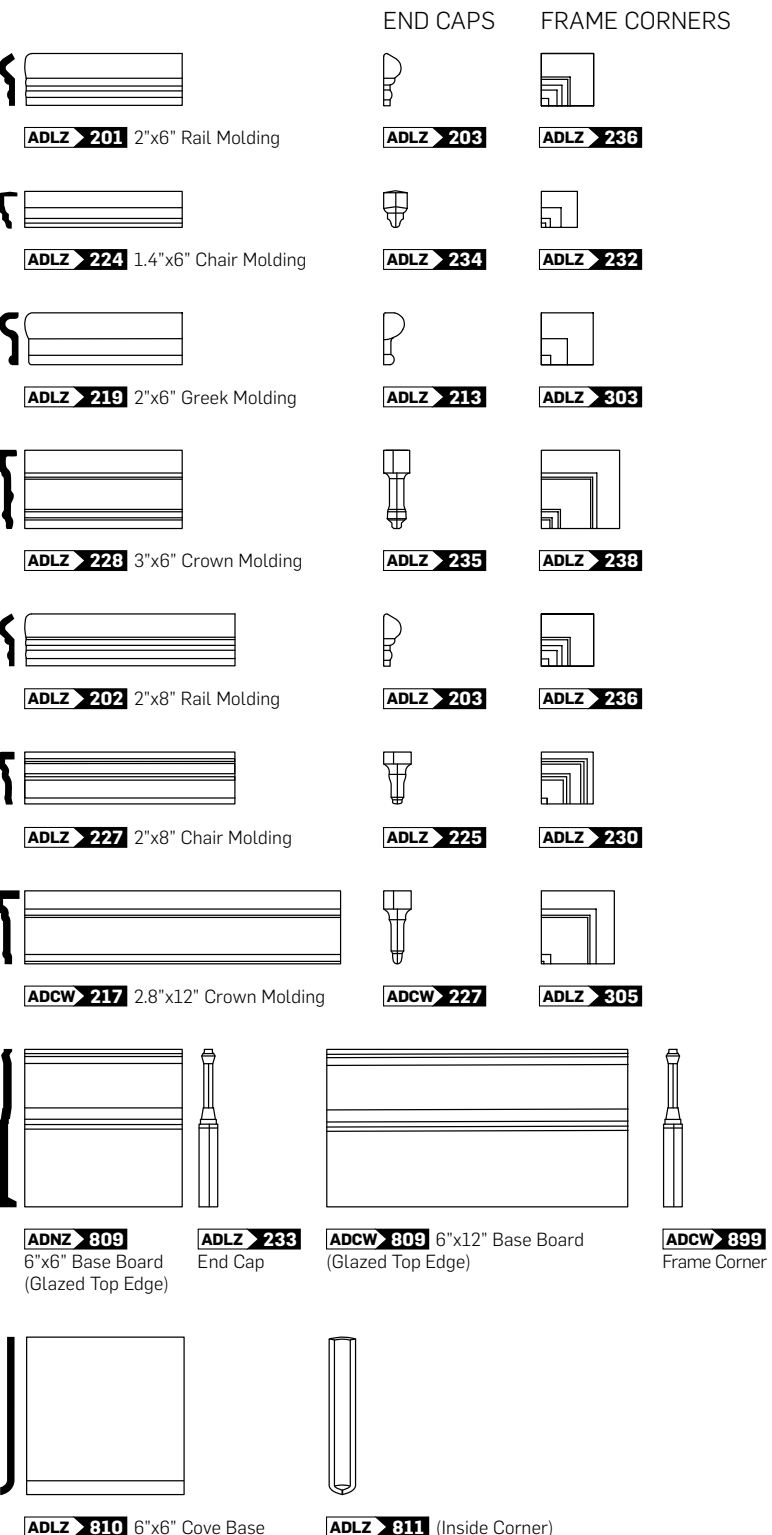

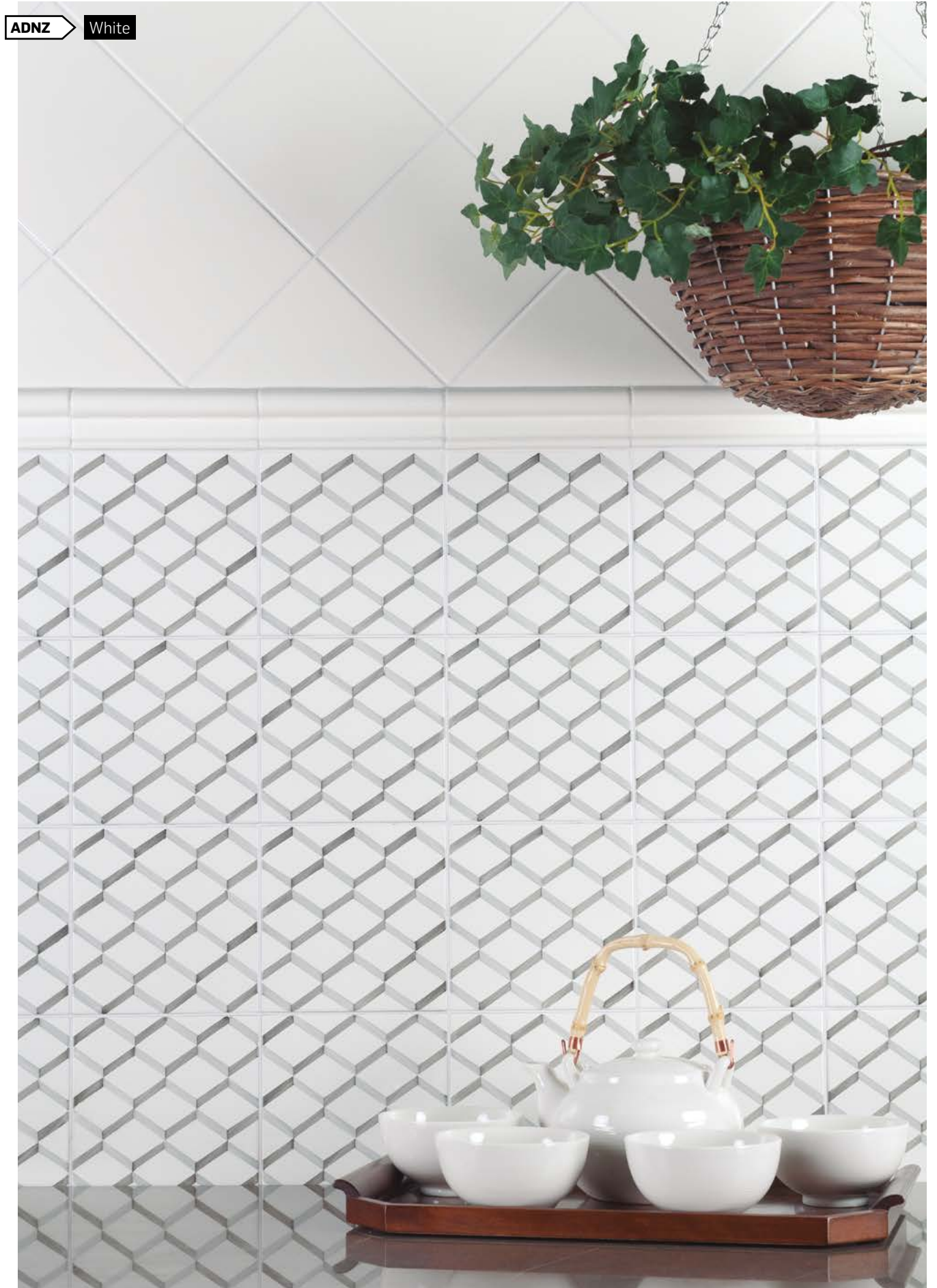

FIELD TILES

FLAT

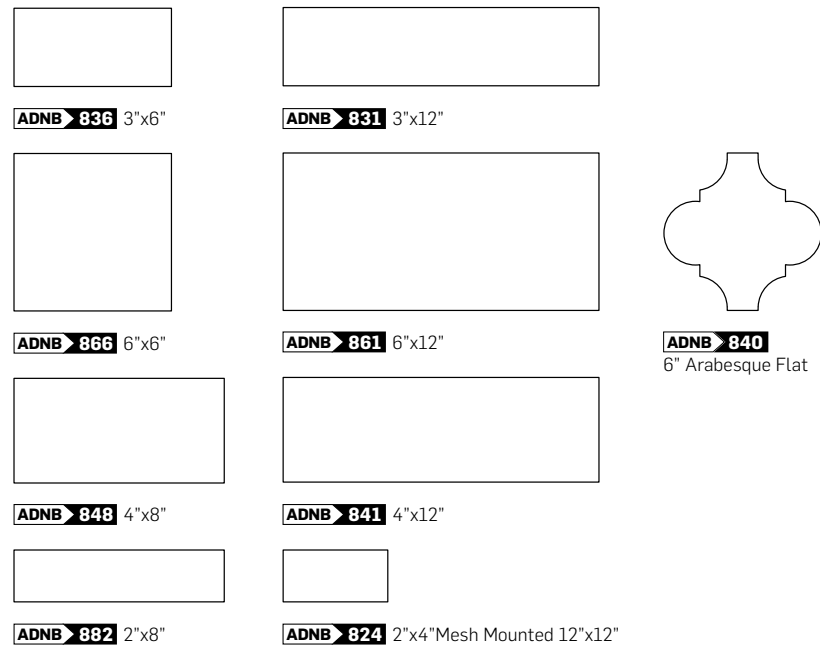

TRIMS

FINISHING EDGES

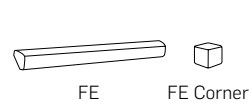

- ADNB 506 FE 0.4"x6"
- ADNB 508 FE 0.4"x8"
- ADNB 500 FE Corner

FLAT BULLNOSES

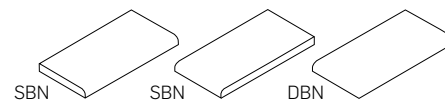

- ADNB 805 3"x6" SBN 6"
- ADNB 806 3"x6" SBN 3"
- ADNB 807 3"x6" DBN Right
- ADNB 808 3"x6" DBN Left
- ADNB 803 6"x6" SBN
- ADNB 804 6"x6" DBN
- ADNB 810 4"x8" SBN 4"
- ADNB 811 4"x8" SBN 8"
- ADNB 812 4"x4" DBN
- ADNB 800 2"x2" DBN
- ADNB 826 2"x6" SBN 6"
- ADNB 828 2"x8" SBN 8"

FLAT GLAZED EDGES

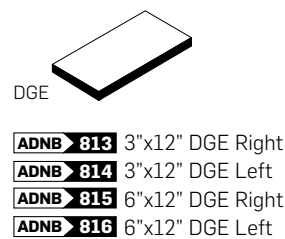

BEVELED

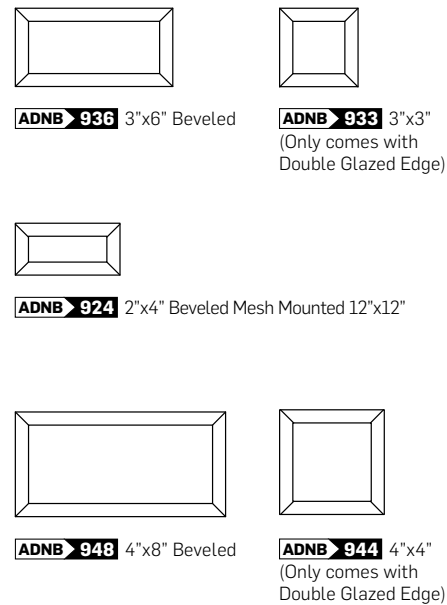

TRIMS

BEVELED GLAZED EDGES

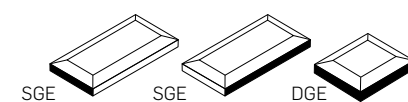

- ADNB 907 3"x6" Beveled SGE 3"
- ADNB 908 3"x6" Beveled SGE 6"
- ADNB 933 3"x3" Beveled DGE
- ADNB 911 4"x8" Beveled SGE 4"
- ADNB 910 4"x8" Beveled SGE 8"
- ADNB 944 4"x4" Beveled DGE

DECORATIVE ACCESSORIES

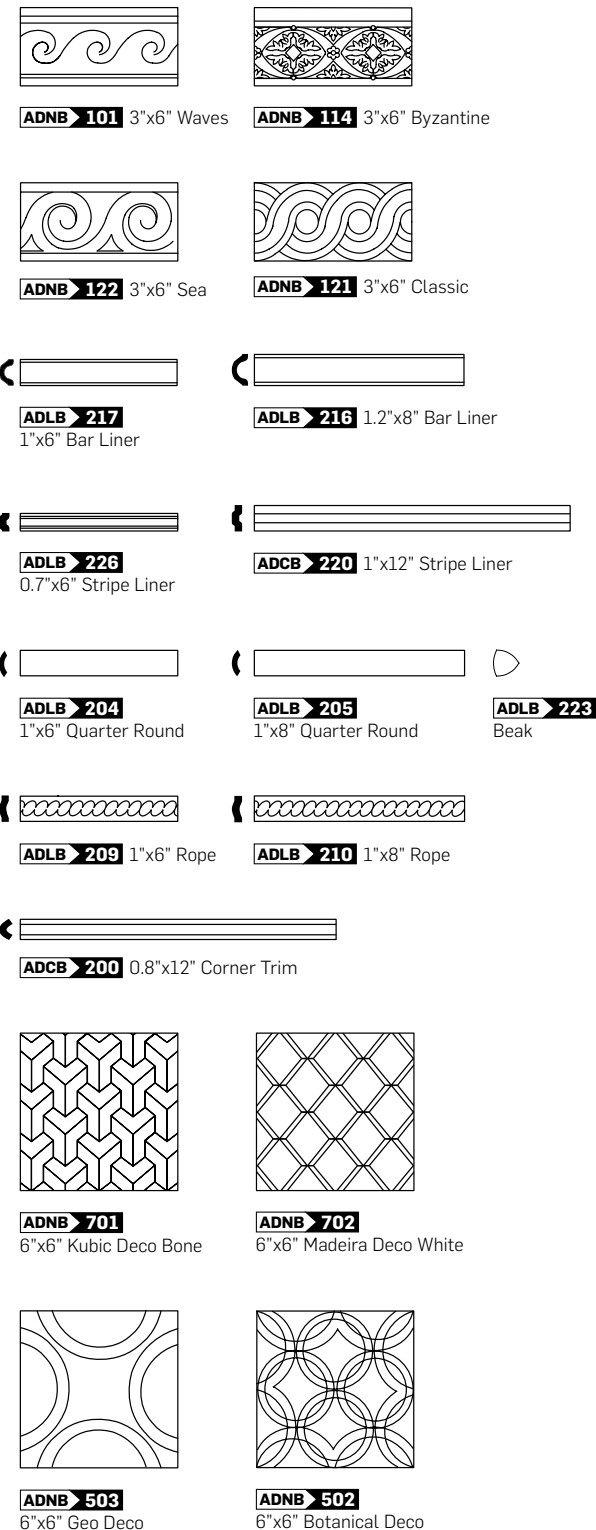

FINISHING TOUCHES

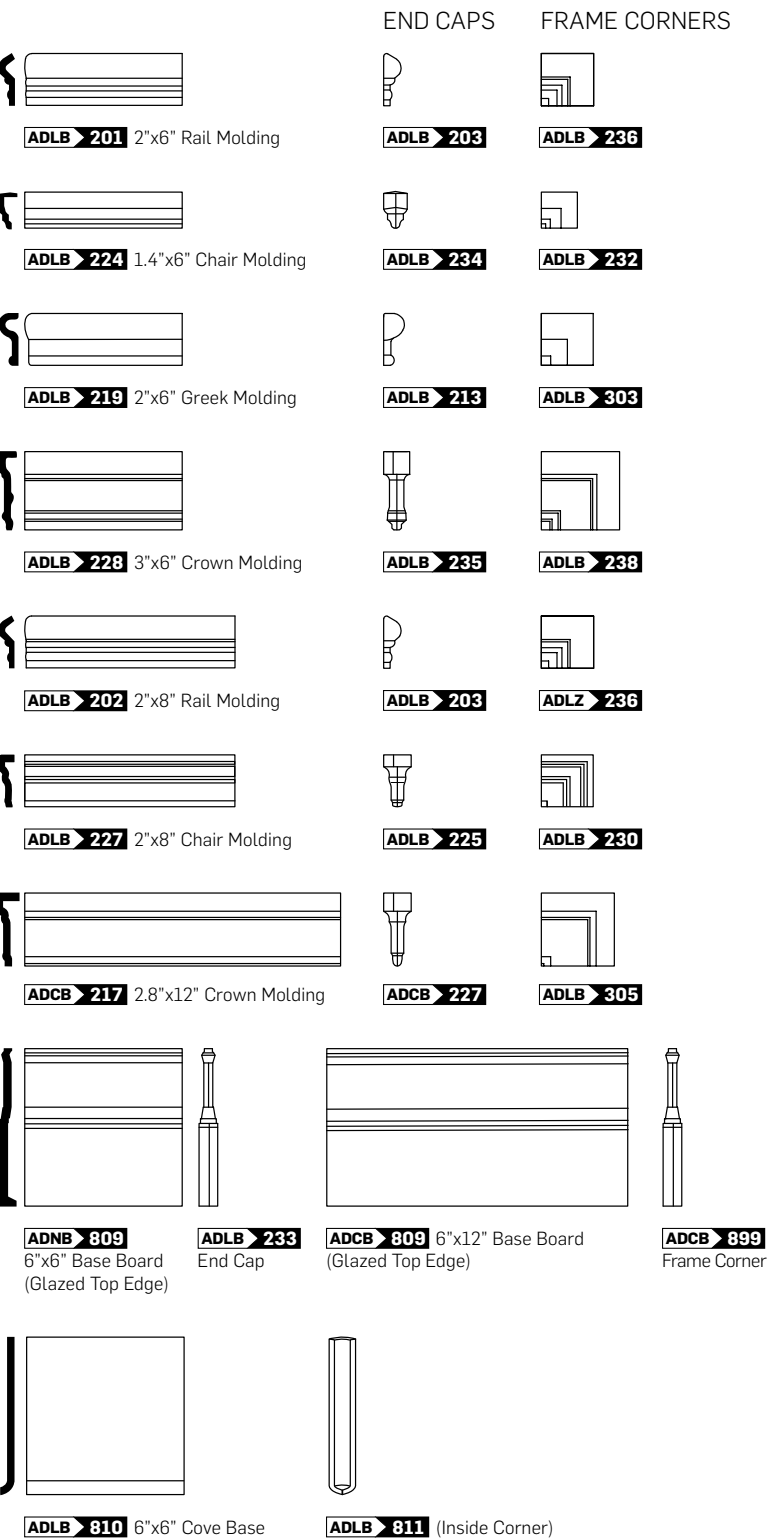

ADNB Bone



ADNB Bone



ADNB Bone



FIELD TILES

FLAT



ADNS 836 3"x6"



ADNS 882 2"x8"

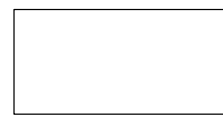

ADNS 848 4"x8"

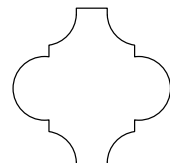

ADNS 840 6" Arabesque Flat

TRIMS

FINISHING EDGES



ADNS 506 FE 0.4"x6"
ADNS 508 FE 0.4"x8"
ADNS 500 FE Corner

FLAT BULLNOSES

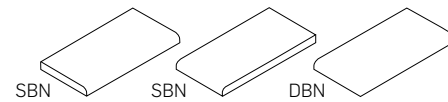

ADNS 805 3"x6" SBN 6"
ADNS 806 3"x6" SBN 3"
ADNS 807 3"x6" DBN Right
ADNS 808 3"x6" DBN Left
ADNS 810 4"x8" SBN 4"
ADNS 811 4"x8" SBN 8"
ADNS 812 4"x4" DBN
ADNS 800 2"x2" DBN
ADNS 826 2"x6" SBN 6"
ADNS 828 2"x8" SBN 8"

BEVELED

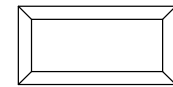

ADNS 936 3"x6" Beveled



ADNS 933 3"x3"
 (Only comes with Double Glazed Edge)

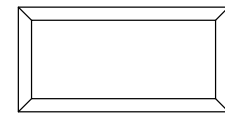

ADNS 948 4"x8" Beveled

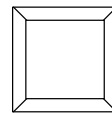

ADNS 944 4"x4"
 (Only comes with Double Glazed Edge)

TRIMS

BEVELED GLAZED EDGES

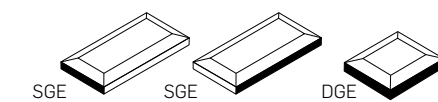

ADNS 907 3"x6" Beveled SGE 3"
ADNS 908 3"x6" Beveled SGE 6"
ADNS 933 3"x3" Beveled DGE
ADNS 911 4"x8" Beveled SGE 4"
ADNS 910 4"x8" Beveled SGE 8"
ADNS 944 4"x4" Beveled DGE

DECORATIVE ACCESSORIES

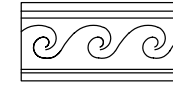

ADNS 101 3"x6" Waves

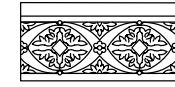

ADNS 114 3"x6" Byzantine



ADLS 217 1"x6" Bar Liner

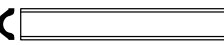

ADLS 216 1.2"x8" Bar Liner



ADLS 226 0.7"x6" Stripe Liner

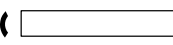

ADLS 204 1"x6" Quarter Round

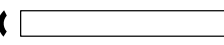

ADLS 205 1"x8" Quarter Round



ADLS 223 Beak

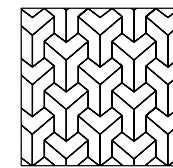

ADNB 701 6"x6" Kubic Deco Bone

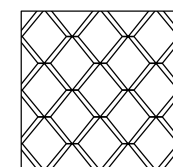

ADNZ 702 6"x6" Madeira Deco White

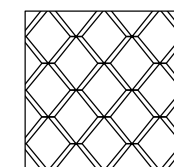

ADNB 702 6"x6" Madeira Deco Bone

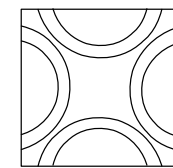

ADNS 503 6"x6" Geo Deco

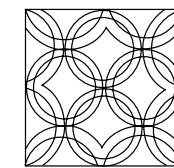

ADNS 502 6"x6" Botanical Deco

FINISHING TOUCHES

END CAPS

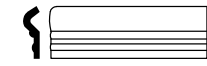

ADLS 201 2"x6" Rail Molding



ADLS 203

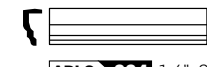

ADLS 224 1.4"x6" Chair Molding



ADLS 234

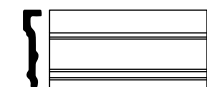

ADLS 228 3"x6" Crown Molding



ADLS 235

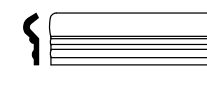

ADLS 202 2"x8" Rail Molding



ADLS 203

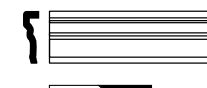

ADLS 227 2"x8" Chair Molding



ADLS 225

FRAME CORNERS



ADLS 236



ADLS 232



ADLS 238



ADLS 236



ADLS 230

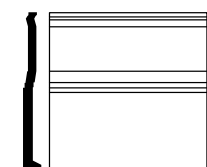

ADNS 809 6"x6" Base Board (Glazed Top Edge)

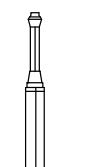

ADLS 233



FIELD TILES

FLAT



ADNM 836 3"x6"

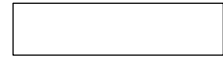

ADNM 882 2"x8"

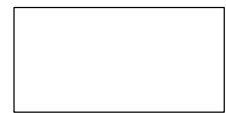

ADNM 848 4"x8"

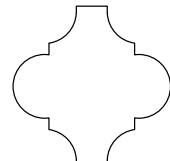

ADNM 840 6" Arabesque Flat

TRIMS

FINISHING EDGES



FE



FE Corner

- ADNM 506** FE 0.4"x6"
- ADNM 508** FE 0.4"x8"
- ADNM 500** FE Corner

FLAT BULLNOSES

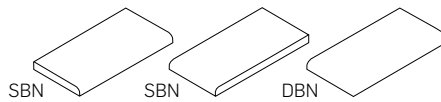

SBN

SBN

DBN

- ADNM 805** 3"x6" SBN 6"
- ADNM 806** 3"x6" SBN 3"
- ADNM 807** 3"x6" DBN Right
- ADNM 808** 3"x6" DBN Left
- ADNM 810** 4"x8" SBN 4"
- ADNM 811** 4"x8" SBN 8"
- ADNM 812** 4"x4" DBN
- ADNM 800** 2"x2" DBN
- ADNM 826** 2"x6" SBN 6"
- ADNM 828** 2"x8" SBN 8"

BEVELED

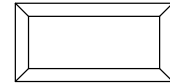

ADNM 936 3"x6" Beveled



ADNM 933 3"x3"
(Only comes with Double Glazed Edge)

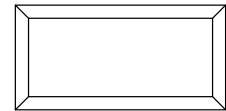

ADNM 948 4"x8" Beveled

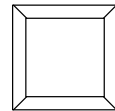

ADNM 944 4"x4"
(Only comes with Double Glazed Edge)

TRIMS

BEVELED GLAZED EDGES

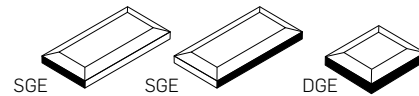

SGE

SGE

DGE

- ADNM 907** 3"x6" Beveled SGE 3"
- ADNM 908** 3"x6" Beveled SGE 6"
- ADNM 933** 3"x3" Beveled DGE
- ADNM 911** 4"x8" Beveled SGE 4"
- ADNM 910** 4"x8" Beveled SGE 8"
- ADNM 944** 4"x4" Beveled DGE

DECORATIVE ACCESSORIES

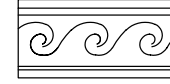

ADNM 101 3"x6" Waves

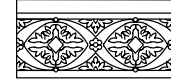

ADNM 114 3"x6" Byzantine



ADLM 217
1"x6" Bar Liner

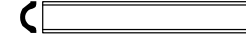

ADLM 216 1.2"x8" Bar Liner



ADLM 226 0.7"x6" Stripe Liner

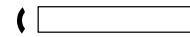

ADLM 204
1"x6" Quarter Round

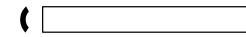

ADLM 205
1"x8" Quarter Round



ADLM 223
Beak

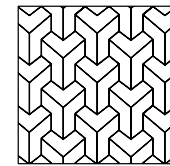

ADNB 701 6"x6" Kubic Deco Bone

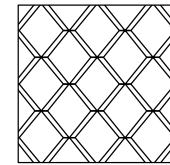

ADNZ 702
6"x6" Madeira Deco White

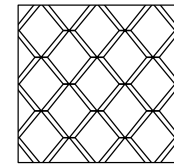

ADNB 702
6"x6" Madeira Deco Bone

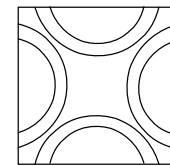

ADNM 503
6"x6" Geo Deco

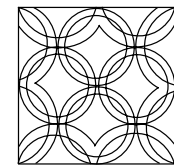

ADNM 502
6"x6" Botanical Deco

FINISHING TOUCHES

END CAPS

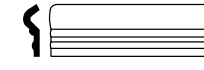

ADLM 201 2"x6" Rail Molding



ADLM 203

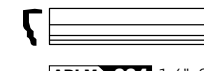

ADLM 224 1.4"x6" Chair Molding



ADLM 234

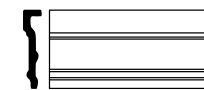

ADLM 228 3"x6" Crown Molding



ADLM 235

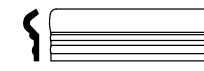

ADLM 202 2"x8" Rail Molding



ADLM 203



ADLM 227 2"x8" Chair Molding



ADLM 225

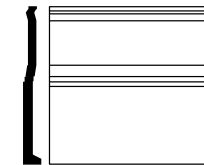

ADNM 809
6"x6" Base Board
(Glazed Top Edge)

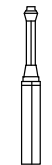

ADLM 233

FRAME CORNERS



ADLM 236



ADLM 232



ADLM 238



ADLM 236



ADLM 230

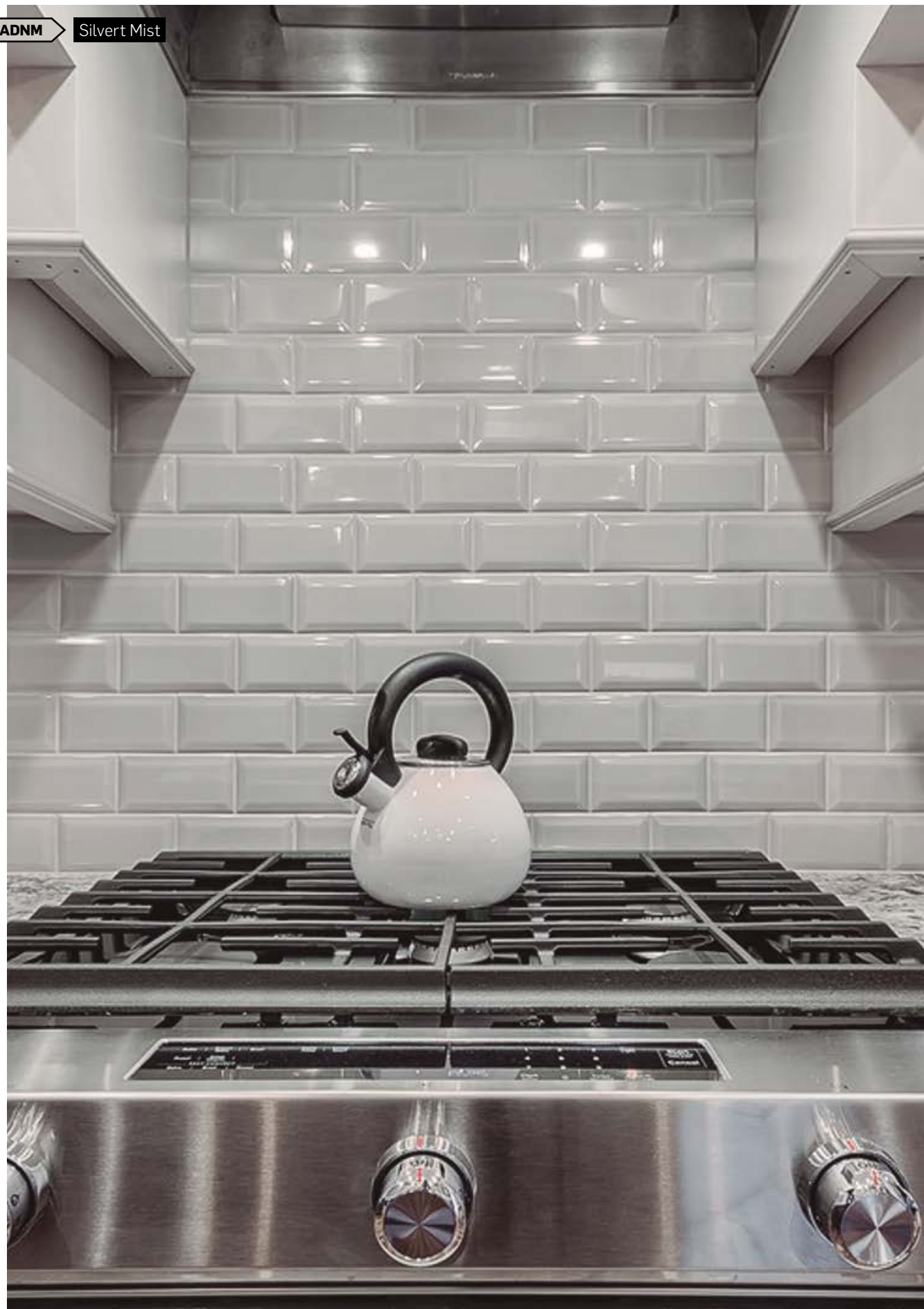

FIELD TILES

FLAT

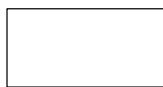

ADNK 836 3"x6"

TRIMS

FINISHING EDGES

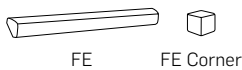

ADNK 506 FE 0.4"x6"
ADNK 500 FE Corner

FLAT BULLNOSES

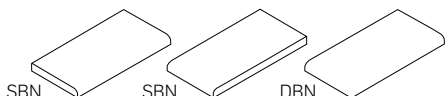

ADNK 805 3"x6" SBN 6"
ADNK 806 3"x6" SBN 3"
ADNK 807 3"x6" DBN Right
ADNK 808 3"x6" DBN Left

BEVELED

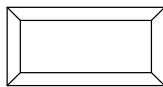

ADNK 936 3"x6" Beveled



ADNK 924 3"x3" Beveled
(Only comes with Double Glazed Edge)

TRIMS

BEVELED GLAZED EDGES

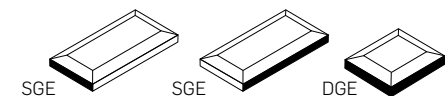

ADNK 907 3"x6" Beveled SGE 3"
ADNK 908 3"x6" Beveled SGE 6"
ADNK 933 3"x3" Beveled DGE

DECORATIVE ACCESSORIES

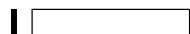

ADLK 213 1"x6" Flat Liner



ADLK 226 0.7"x6" Stripe Liner

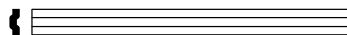

ADCK 220 1"x12" Stripe Liner

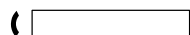

ADLK 204 1"x6" Quarter Round



ADLK 223 Beak

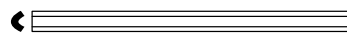

ADCK 200 0.8"x12" Corner Trim

FINISHING TOUCHES

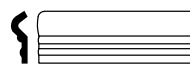

ADLK 201 2"x6" Rail Molding

END CAPS



ADLK 203

FRAME CORNERS



ADLK 236

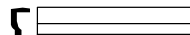

ADLK 224 1.4"x6" Chair Molding



ADLK 234



ADLK 232



ADCK 217 2.8"x12" Crown Molding



ADLK 227



ADLK 305



ADLK 227 2"x8" Chair Molding



ADLK 225



ADLK 230

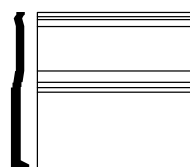

ADNK 809 6"x6" Base Board
(Glazed Top Edge)



ADNK 233 End Cap

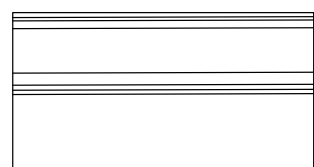

ADCK 809 6"x12" Base Board
(Glazed Top Edge)



ADCK 899 End Cap

